

15-pin female / 15-pin female

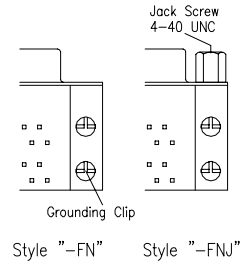

without grounding clips just 4 mounting holes	without grounding clips, just 4 mounting holes; 4 jack screws 4-40 UNC mounted	with 4 grounding clips (as above drawing)	with 4 grounding clips; 4 jack screws 4-40 UNC mounted	Distance Dimensions
SDD-1515-1-95-F	SDD-1515-1-95-FJ	SDD-1515-1-95-FN	SDD-1515-1-95-FNJ	„A“ = 22.86 „B“ = 35.41
SDD-1515-2-95-F	SDD-1515-2-95-FJ	SDD-1515-2-95-FN	SDD-1515-2-95-FNJ	„A“ = 19.05 „B“ = 31.60
SDD-1515-3-95-F	SDD-1515-3-95-FJ	SDD-1515-3-95-FN	SDD-1515-3-95-FNJ	„A“ = 15.87 „B“ = 28.42
if with Ferrite Filter: -FS	if with Ferrite Filter: -FSJ	if with Ferrite Filter: -FSN	if with Ferrite Filter: -FSNJ	

15-pin male / 15-pin male

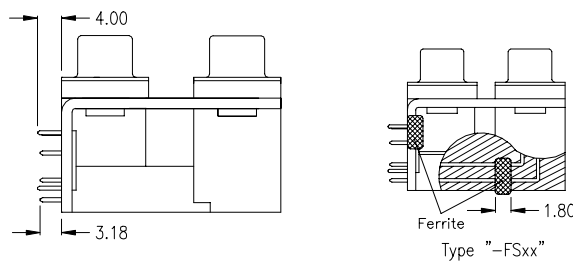
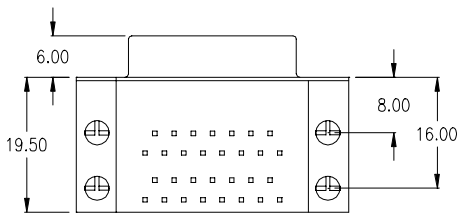
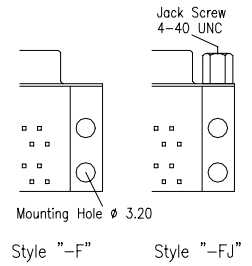
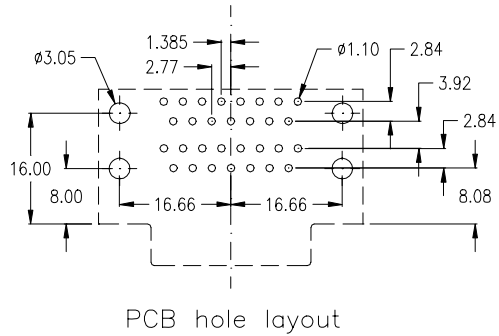
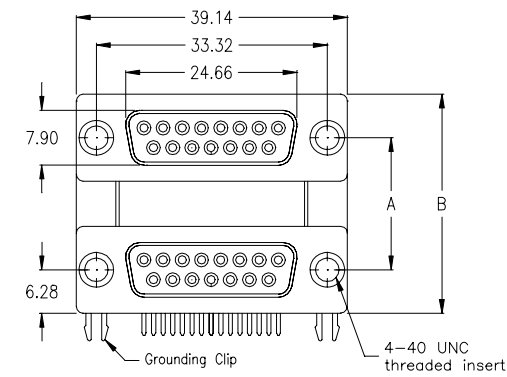
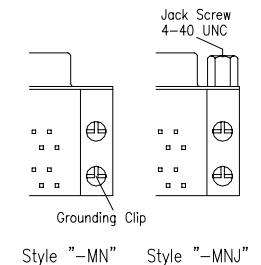
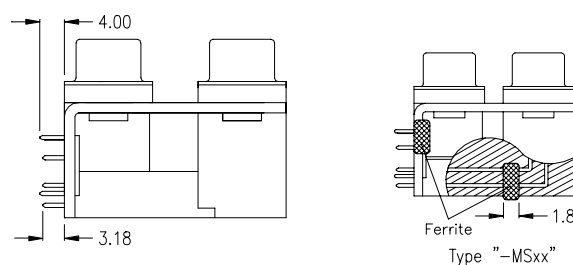
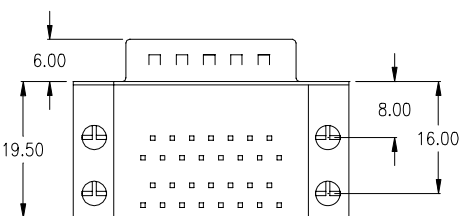
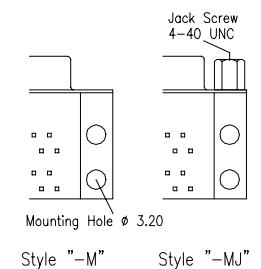
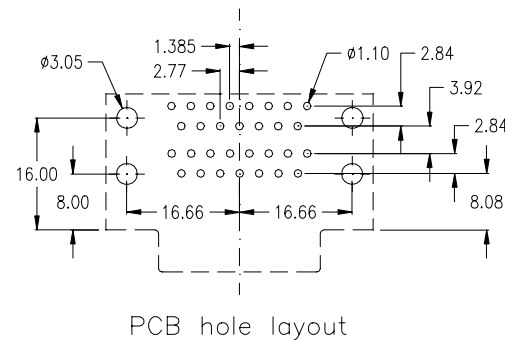
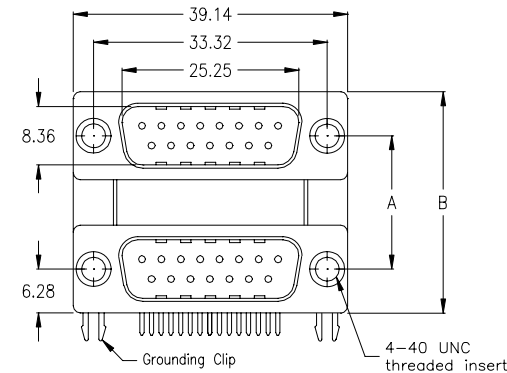

without grounding clips just 4 mounting holes	without grounding clips, just 4 mounting holes; 4 jack screws 4-40 UNC mounted	with 4 grounding clips (as above drawing)	with 4 grounding clips; 4 jack screws 4-40 UNC mounted	Distance Dimensions
SDD-1515-1-95-M	SDD-1515-1-95-MJ	SDD-1515-1-95-MN	SDD-1515-1-95-MNJ	„A“ = 22.86 „B“ = 35.41
SDD-1515-2-95-M	SDD-1515-2-95-MJ	SDD-1515-2-95-MN	SDD-1515-2-95-MNJ	„A“ = 19.05 „B“ = 31.60
SDD-1515-3-95-M	SDD-1515-3-95-MJ	SDD-1515-3-95-MN	SDD-1515-3-95-MNJ	„A“ = 15.87 „B“ = 28.42
if with Ferrite Filter: -MS	if with Ferrite Filter: -MSJ	if with Ferrite Filter: -MSN	if with Ferrite Filter: -MSNJ	

15-pin female / 15-pin male

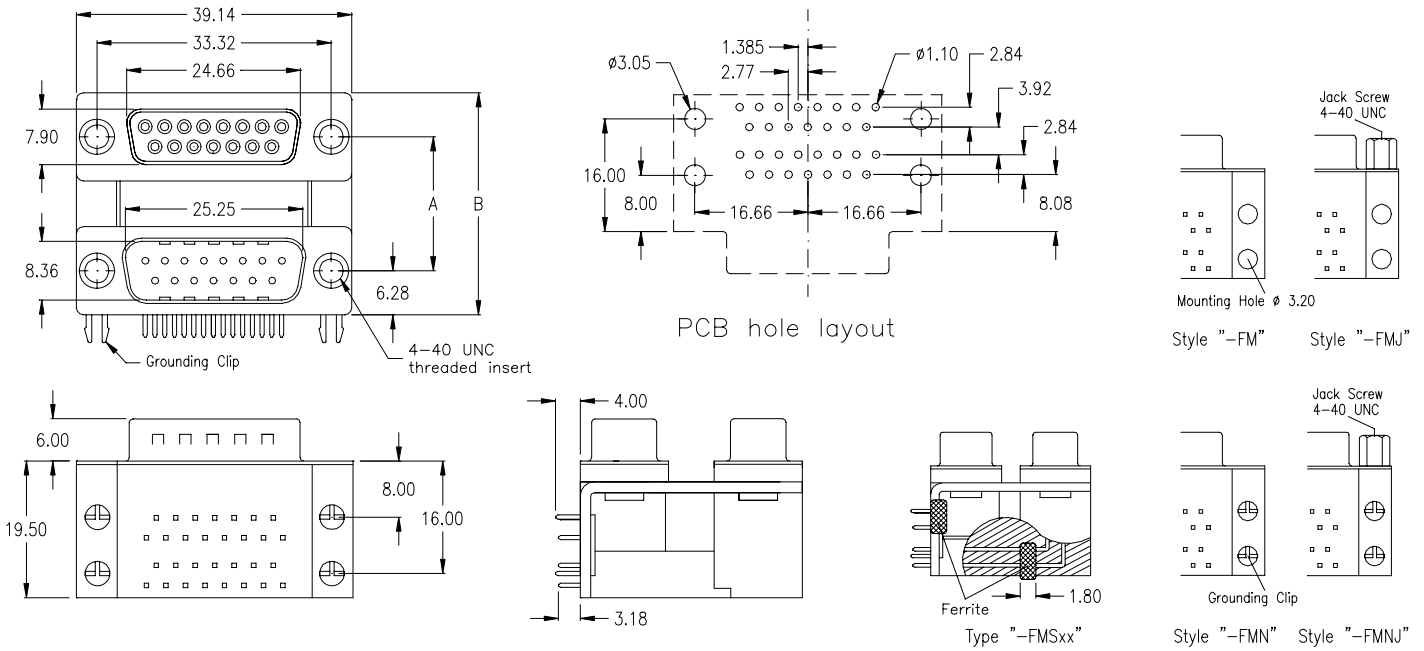

without grounding clips just 4 mounting holes	without grounding clips, just 4 mounting holes; 4 jack screws 4-40 UNC mounted	with 4 grounding clips (as above drawing)	with 4 grounding clips; 4 jack screws 4-40 UNC mounted	Distance Dimensions
SDD-1515-1-95-FM	SDD-1515-1-95-FMJ	SDD-1515-1-95-FMN	SDD-1515-1-95-FMNJ	„A“ = 22.86 „B“ = 35.41
SDD-1515-2-95-FM	SDD-1515-2-95-FMJ	SDD-1515-2-95-FMN	SDD-1515-2-95-FMNJ	„A“ = 19.05 „B“ = 31.60
SDD-1515-3-95-FM	SDD-1515-3-95-FMJ	SDD-1515-3-95-FMN	SDD-1515-3-95-FMNJ	„A“ = 15.87 „B“ = 28.42
if with Ferrite Filter: -FMS	if with Ferrite Filter: -FMSJ	if with Ferrite Filter: -FMSN	if with Ferrite Filter: -FMSNJ	

15-pin male / 15-pin female

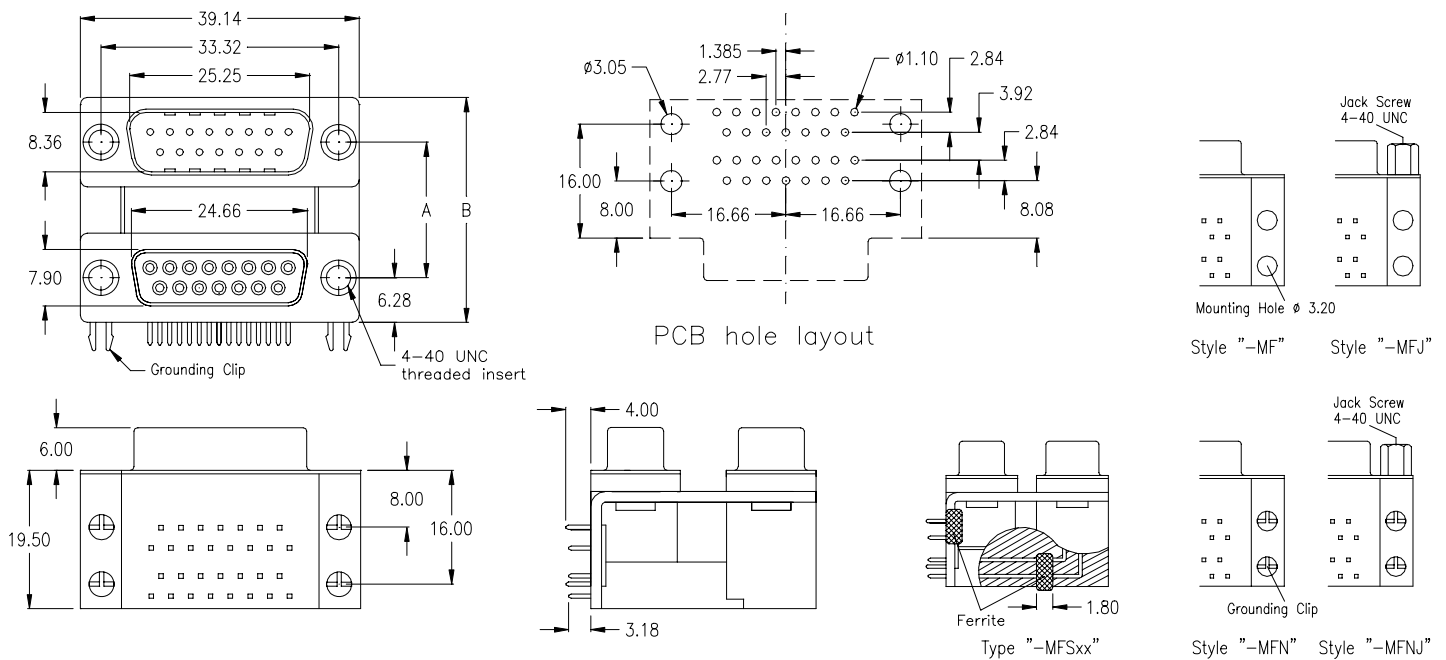

without grounding clips just 4 mounting holes	without grounding clips, just 4 mounting holes; 4 jack screws 4-40 UNC mounted	with 4 grounding clips (as above drawing)	with 4 grounding clips; 4 jack screws 4-40 UNC mounted	Distance Dimensions
SDD-1515-1-95-MF	SDD-1515-1-95-MFJ	SDD-1515-1-95-MFN	SDD-1515-1-95-MFNJ	„A“ = 22.86 „B“ = 35.41
SDD-1515-2-95-MF	SDD-1515-2-95-MFJ	SDD-1515-2-95-MFN	SDD-1515-2-95-MFNJ	„A“ = 19.05 „B“ = 31.60
SDD-1515-3-95-MF	SDD-1515-3-95-MFJ	SDD-1515-3-95-MFN	SDD-1515-3-95-MFNJ	„A“ = 15.87 „B“ = 28.42
if with Ferrite Filter: -MFS	if with Ferrite Filter: -MFSJ	if with Ferrite Filter: -MFSN	if with Ferrite Filter: -MFSNJ	



mechanical data

Mating force per contact	≤ 3,4 N
Unmating force per contact	≥ 0,2 N
Temperature range	-55° C to +105° C
Processing temperature wave solder (solder bath)	+250°C +0/-5°C for 10sec.
Processing temperature SMT and "pin in paste"	+250°C +0/-5°C for 20~40sec.
Moisture absorption from air 50% rh	0,10%
IDC Connector types accept AWG 26 or AWG 28 standard wire	

materials and plating (RoHS compliant)

Insulator for wave solder technology, standard black - PC 99 colourful insulator	thermoplastic glassfilled UL 94V – 0 Yellowish brown - Pantone # 131C 15-pos. female Burgundy - Pantone # 235C 25-pos. female Teal - Pantone # 322C 9-pos. male Blue - Pantone # 661C HD 15-pos. female
Insulator for SMT and "Pin-In-Paste"	Nylon UL 94V-0
Shell	Steel, Ni plated
Bracket	Brass, tin plated
Male contact - plating	Copper Alloy (Standard; others on request) -95 = solder side Sn; contact side Au over Ni -55 = solder and contact side Au over Ni
Female contact - plating	Copper Alloy (Standard; others on request) -95 = solder side Sn; contact side Au over Ni -55 = solder and contact side Au over Ni
D-Sub Accessories (page 70) plating	-NN = Ni

electrical data

max. Current rating	5 A/25°C 3 A/70°C (High Density types 3A / IDC types 1A)
Operating voltage	250 V
Test voltage between contacts	1000 V / 50/60 Hz / 1 Minute
Test voltage between shell and contacts	1000 V / 50/60 Hz / 1 Minute
Resistance between mated contacts	< 30 m Ω
Insulation resistance	≥ 1000 M Ω at 500V DC
Dielectric strength	1000 V AC min. for 1 Minute
Volume resistivity	10 ¹⁶ Ω cm (ASTM-D 257)

available performance classes

E-tec D-Sub connectors comply with Performance Class 3 (min. 50 contact cycles).

Please contact E-tec first for availability of Performance Class 2 (min. 200 contact cycles) and 1 (min. 500 contact cycles)

D-Sub with Filter (ferrite)

Frequency range	10 - 300 MHz
Impedance	5 MHz - 15 Ω
	25 MHz - 30 Ω
	100 MHz - 50 Ω
	300 MHz - 75 Ω

