

1.27mm pitch Pin Header  
- SMT - low profile dual row

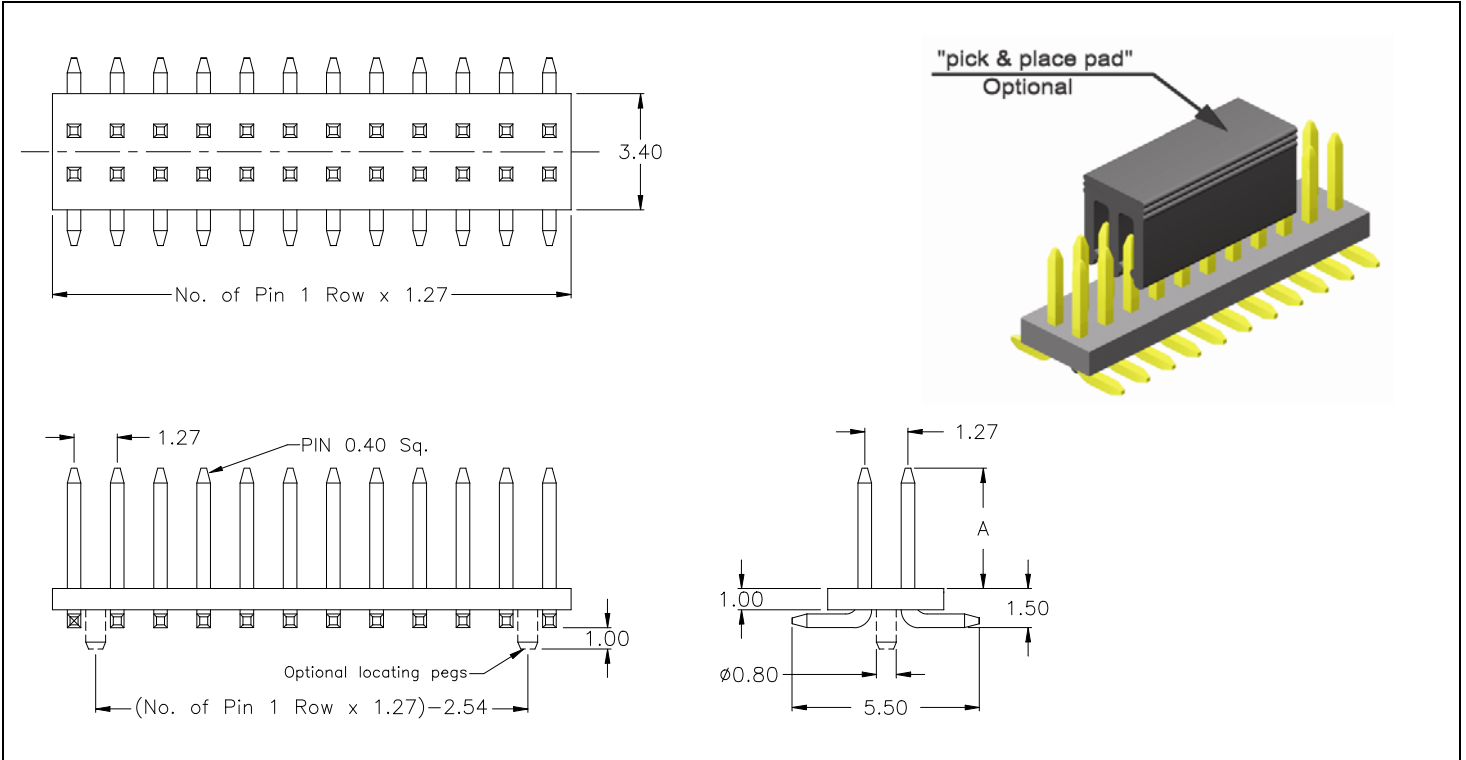

**APPLICATION AND FEATURES**

- **Standard: tube packing and without "locating pegs"**
- Assures reliable PC Board connections
- Low profile insulator
- Mates with 1,27mm pitch Female Headers

**PCB Surface Mount Layout**

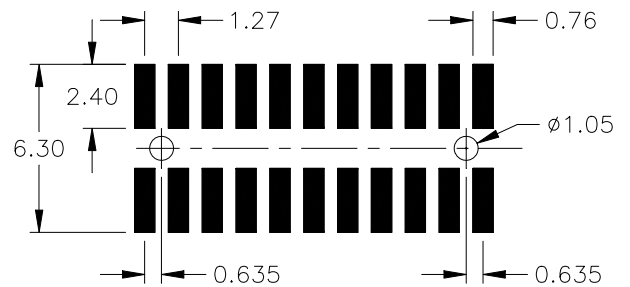

**SPECIFICATIONS**

Current rating	1 A
Insulator resistance	1000 MΩ min.
Contact resistance	20 mΩ max.
Dielectric withstanding voltage	500 V AC

Operating temperature	- 40° to +105°C
Processing temperature	+250°C +0/-5°C for 20sec.
Contact material	(RoHS compliant) Copper alloy
Insulator material	(RoHS compliant) Nylon UL 94 V-0

**How to order**

SS2 - xxx - H xx/x - 55 /11 X

Nbr of contacts	Terminal style	DIM "A"	Plating	Packing and "pick & place pad" Option
without locating pegs: <b>006 to 100</b>	<b>70/0</b>	3.00mm	<b>55</b> = gold	<b>without "locating pegs"</b>
with locating pegs: <b>008 to 100</b>	<b>70/1</b>	10.00mm	Other platings on request	<b>A</b> = tube packing; with pick & place pad
	<b>70/2</b>	6.50mm		<b>B</b> = reel packing; with pick & place pad
	Other dimensions on request			<b>with "locating pegs"</b> (available only from 008 to 100 contacts)
				<b>C</b> = tube packing; without pick & place pad
				<b>D</b> = tube packing; with pick & place pad
				<b>E</b> = reel packing; with pick & place pad

# 1.27mm - SMT - Pin Header

dual row 1.27mm x 2.54mm

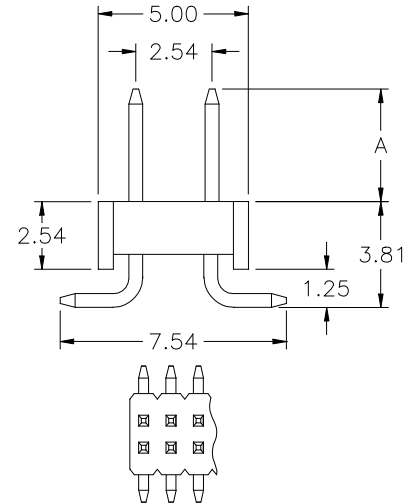
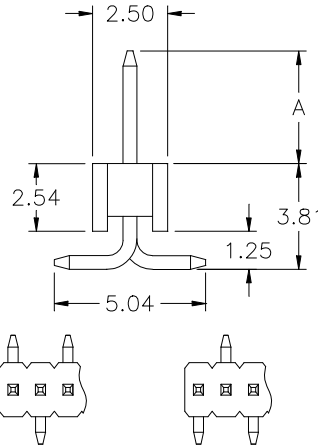
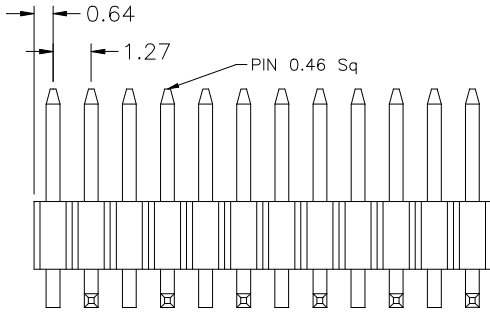
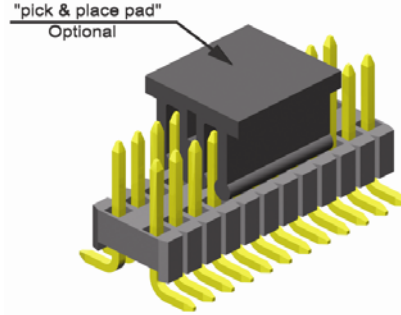
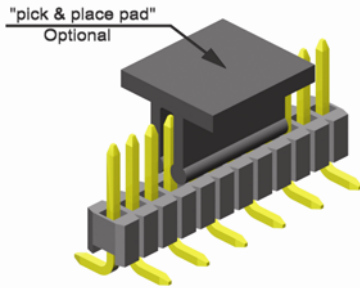

foot style: **380**      **381**      **380**

## SPECIFICATIONS

Current rating	1 A
Insulator resistance	5000 MΩ min.
Contact resistance	20 mΩ max.
Dielectric withstanding voltage	500 V AC
Operating temperature	- 40° to +105°C
Processing temperature	+250°C +0/-5°C for 5sec.
Contact material (RoHS compliant)	Brass
Insulator material (RoHS compliant)	Nylon UL 94 V-0

## PCB Surface Mount Layout

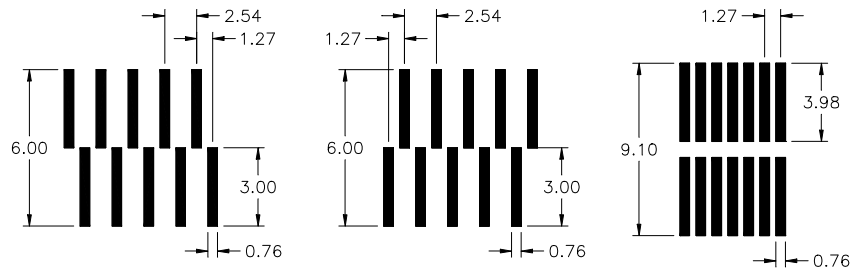

foot style: **380** (single row)      **381** (single row)      **380** (dual row)

## How to order

SS x - xxx - H xxx / x - 55 / 1 X

Rows	Nbr of contacts	foot style	Pin style	DIM "A"	Plating	Packing and "pick & place pad" Option
1 = single row	003 to 050	380 / 0		2.80mm	55 = gold Other plating on request	A = tube packing; with pick & place pad B = reel packing; with pick & place pad
		381 / 0		2.80mm		
2 = dual row	006 to 100	380 / 0		2.80mm		
		380 / 1		4.50mm		
		380 / 2		5.50mm		
Other dimensions on request						